

LHP UPDATE

Quarterly Newsletter

Issue 10 May 2010

*Geared up to
expand 'n excel*

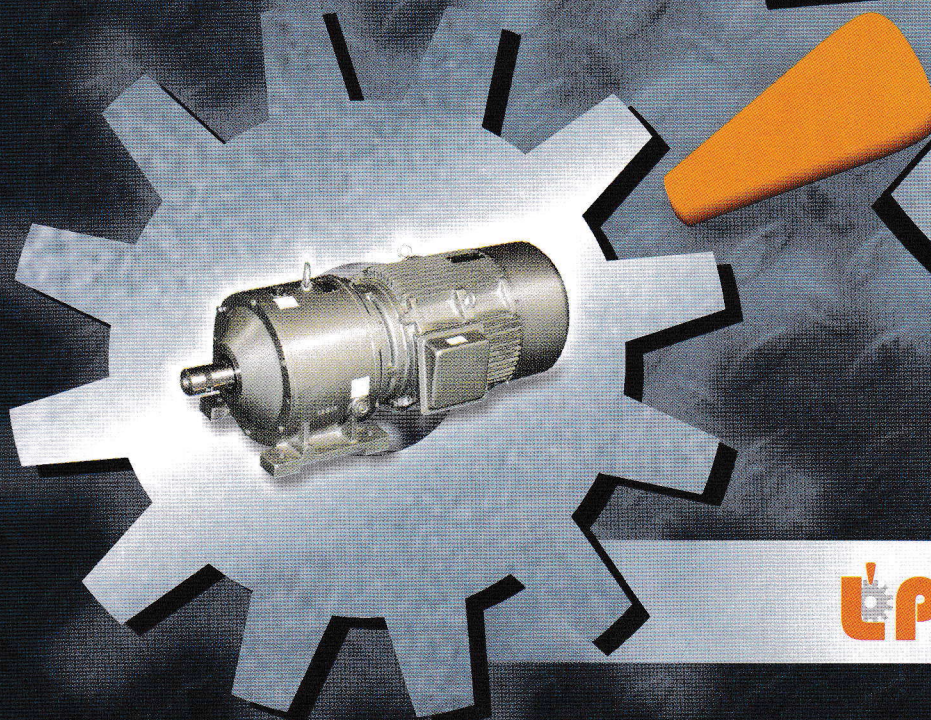

Power

Approval from Avant Garde

New range of Gearmotors

30% growth recorded

Lhp[®]
MOTORS PUMPS
Driven by Commitment

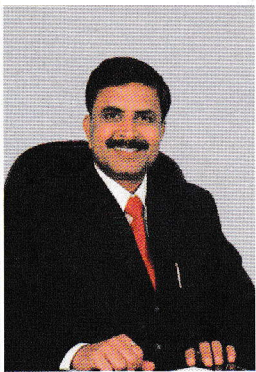

The Mentor Speaks

Dear readers,

All geared up to expand and excel? Yes, we are! The recent developments at LHP stand a glowing testimony to our determined, steady march towards our goal through expansion and achieving excellence.

I am glad to inform you that LHP is successful in achieving more than 30% growth in this financial year and has reached the landmark figure of rupees 1380 million annual sales turnover. The achievement stands out remarkably on the backdrop of global recessionary trends.

Another noteworthy expansion activity at LHP is the launch of a new range of Gearmotors by the brand name **EPower**. The brand was formally launched in ELECRAMA 2010. This new brand is the culmination of two things that always keep LHP ahead on the frontiers of technology.

One, our conviction in the logical expansion of our product range, and two, the pressing demand from our customers for Gearmotors and Gearboxes for their specific requirements. In our pursuance of excellence, we have invested more than 50 million rupees in equipping our newly expanded Gearmotors

manufacturing plant with high-precision machines for gear manufacturing, calibration equipments like 3D CMM, gear profile tester and in-house heat treatment facility. The outcome is our best-equipped Gearmotors Division. We are happy that customers have welcomed our initiative and are placing orders.

LHP's expansion reflects in the induction of highly qualified, talented and experienced team members on board. We have also invigorated our marketing efforts to enhance reach and expand client base through activities like exhibitions. Witness our presence in more exhibitions this year.

I am sure that this issue of LHP Update will give you an inspiring picture of committed efforts by our team pledged to become a Rs. 2500 million company by 2012.

I personally congratulate the LHP team and thank our customers, vendors and associates for their immense trust in us.

Sincerely yours,

Sharadkrishna Thakre
Managing Director

Coveted Approvals

The tally of quality approvals for LHP motors from various renowned clients now crosses over 100. The recent additions being, **Neyveli Lignite Corporation**, **PDIL** and **Avant Garde Engineers**. Representatives from these well-known companies assessed and evaluated LHP. They were happy with the test results based on several stringent parameters and also appreciated our best-equipped plant and manufacturing practices being followed. Now, LHP is a registered vendor for these renowned organisations. Various departments at LHP - Production, QA and R&D are always on their toes as our motors are subjected to various tests by technical experts from discerning companies in India and abroad. This ensures not only approvals for our motors, but also appreciation of our QA systems and world-class manufacturing practices. Result? LHP's presence in hundreds of companies all over India and in different countries.



Gearmotors debut at ELECRAMA 2010

January 20th, 2010 10 a.m., NSE Complex, Mumbai. The stage was all set for a grand event. LHP launched its new brand of Gearmotors and Gearboxes - **LPower**

Our several esteemed clients were among the thousands of visitors witnessing a sleek preview of LPower range. The atmosphere was charged with wide admiration and compliments for a much-awaited announcement from LHP.

Managing Director, Mr. Sharadkrishna Thakre was personally present to interact with curious visitors. The highlight of the event was the visit of Hon. **Mr. Sushilkumar Shinde, Union Minister of Power** who inaugurated the exhibition and also made it a point to visit LHP - a fast growing company from his home town - Solapur.

Another star attraction on the LHP stall was our 355 frame motor flaunting its charming, enviro-friendly green colour.

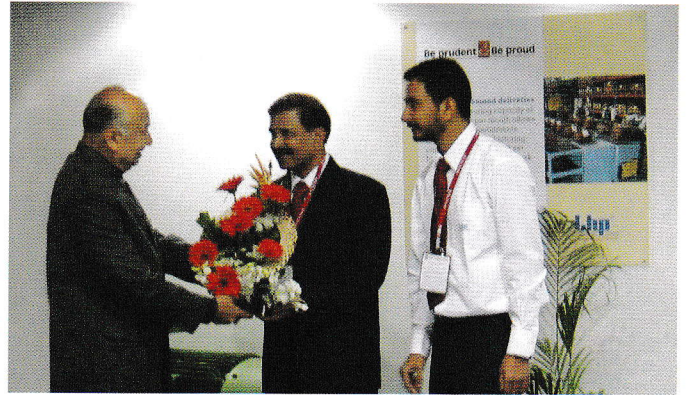

Exhibitions are opportunities for us to display our prowess, interact with customers and understand them well. LHP stalls at industrial exhibitions are always like a fountain of energy, cheer and give-and-take of thoughts. Elecrama 2010 was not an exception to this.

For LHP, Elecrama symbolised a promise of ever-expanding customer base and business in India and abroad.

Techno 4 Exhibition



LHP participated in Techno4 Exhibition held in Coimbatore from April 9-11, 2010. Visitors included eminent people from industries in Tamil Nadu and students from various engineering colleges. By visiting LHP stall, they were delighted to know more about a leading motor brand. It was a good opportunity for us to interact with our regular clients in Coimbatore and update them on our recent developments. We thank all the visitors. The success of this exhibition mainly attributes to the dedicated efforts from Mr. Sabir Shaikh from Market Promotion department, Mr. Balakreeshnan - Regional Marketing Head at Coimbatore, Mr. Keerthi Kumar - Regional Marketing Head, Bangalore and Mr. Muthukumar.

L[!]Power

Gearboxes and Gearmotors

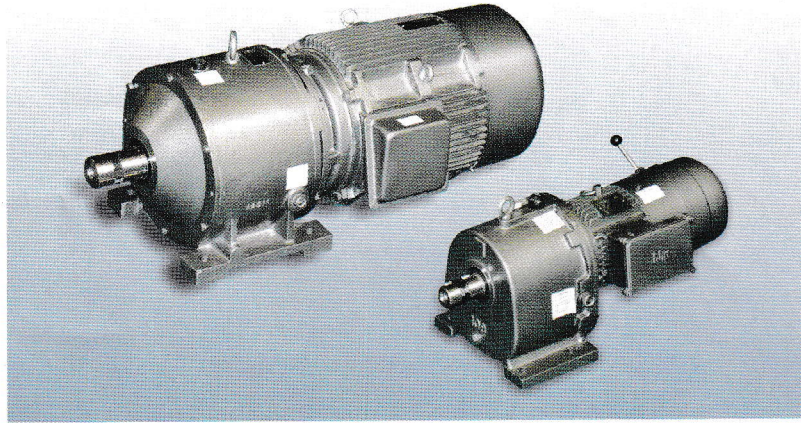

Introducing



January 2010 was a landmark month in the journey of LHP. After successfully establishing LHP as a high quality and 'Value-for-money' brand for motors, Laxmi Druken Komponents Pvt. Ltd., The associate company of LHP, introduced L'Power brand of Gearmotors and Gearboxes.

L'Power was formally launched in ELECRAMA 2010. Orders started pouring in after its formal launch since the customers knew about it much in advance. We are fully equipped to cater to this demand and in 2009 invested more than 50 million rupees in the latest technology, high-precision machines and plant expansion. Now, this modernised facility houses captive gear hobbing machines, heat treatment plant and calibration and test equipments.

The experienced team of managers and engineers at L'Power is headed by Mr. Aditya Thakre.

We cordially invite you for a visit to our new facility and are eager to know your expectations from us. The committed team at LHP is all set to ensure delight as usual.

The modernised facility is equipped with the state-of-the-art

- Gear manufacturing facility with CNC, gear hobbing, gear grinding, heat treatment plant with computerised metal structure testing
- CMM for dimensional accuracy measurement of gearbox housing
- CNC lead and profile tester to ensure quality and accuracy of gears at the manufacturing stage itself
- In-house standard room for calibration of gauges and measuring instruments.

The modernised facility is equipped with the following

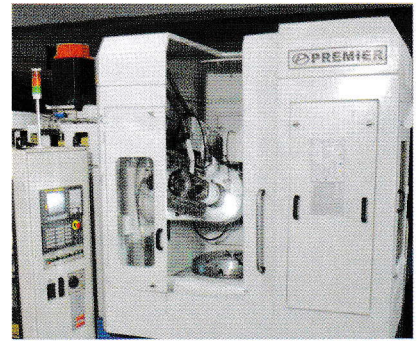

Gear hobbing machines



Heat treatment plant

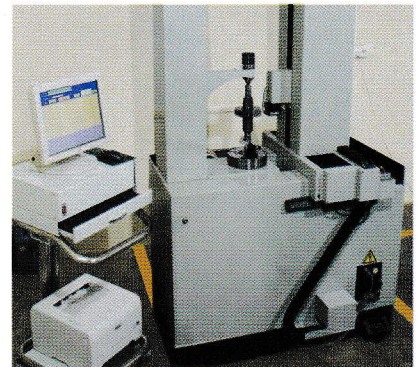

CNC lead and profile tester

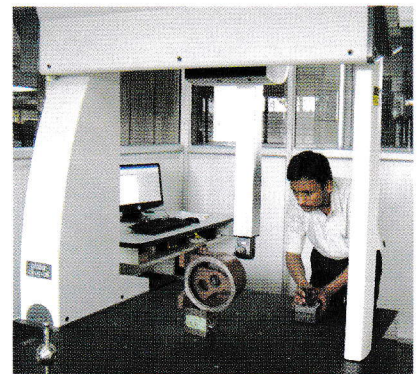

CMM for dimensional accuracy measurement of gearbox housing



Well-equipped machine shop



Mr. Iwasaki, Mr. Pritham Rane & Mr. Prashant Phalke



Mr. Choudhari & Mr. Sadukhan

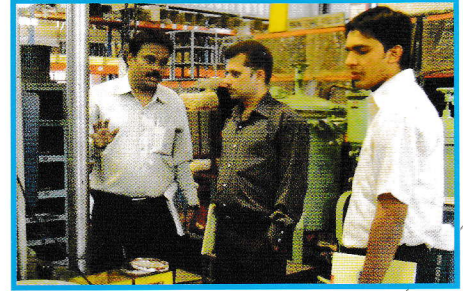

Mr. Bhargava & Mr. Mahajan

Visitors at LHP



Mr. Karpe, Mr. Bhutada & Mr. Ved

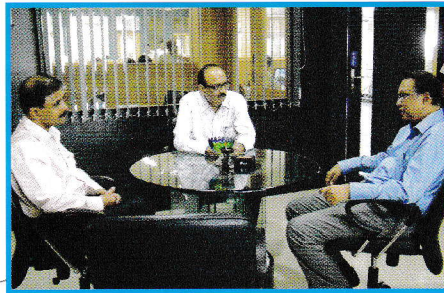

Mr. Ravi Chafalkar



Mr. Wanner, Mr. Kishor & Mr. Dhananjay

Joy of fulfilling Corporate Social Responsibility

"Nine tenths of education is encouragement".
- Anatole France



The LHP campus is an eternal source of encouragement for students in and around Solapur. Twenty Mechanical Engineering students from Walchand Institute of Technology participated in a **Fast-Motor-Assembly Competition** held in LHP on 6th February 2010. The students liked the concept, took up the challenge and enjoyed the process of building motors in a record time. The winning group was rewarded with a certificate and memento.

Mr. Sharadkrishna Thakre, Managing Director of LHP was the chief guest of honour at the students' gathering - Snehsammelan, organised by Rotary Club of Solapur, at **Swagati School - an institute dedicated to the welfare and training of special children**. The children are overcoming obstacles and making progress with the motto 'Hum Honge Kamyab Ek Din'. Mr. Thakre's enlightening speech instilled inspiration in the hearts of the organisers. The culminating point of the event was Mr. Thakre's assurance that these special children will be offered employment in LHP when they would grow up.





Baburao R. Shahane

WHO'S WHO?

Name of team member	: Baburao R. Shahane
Age	: 54 years
Family status (married to)	: Mrs. Kanyakumari
Names of children	: Siddheshwari, Maheshwari, Ganesh
Qualification / Experience	: B.A. (Hons.) 26 years' experience
Date of joining LHP	: 1st February 1984
Present designation in LHP	: Manager - Purchase
Responsibility shouldered in LHP	: Purchase of raw materials required for the manufacture of motors & pumps
Special achievements	: Active participation in social activities
Hobby	: Watching TV & reading articles
Favourite snack	: Vegetarian snacks
Favourite celebrity	: Mohammed Rafi
Favourite holiday spot	: Hampi, Karnataka
Strength	: Developing relationships to meet targets
Weakness	: Expecting people to achieve more
Message to colleagues	: Work as a team and achieve targets

Welcome to join team LHP



Sudhir Mahajan
General Manager - H.R.



P. M. Devadkar
Manager - Gear Shop



Vijaykumar Dhole
Sr. Engineer
Machine Shop



Manoj Jokare
Engineer
Pattern Shop



A. P. Kulkarni
Engineer - R & D



Rajesh Bijjargi
Engineer - Production



Viresh Pawate
Engineer
Hardware & Networking

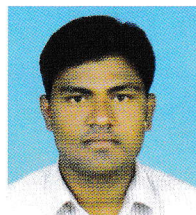

Afroz Mulani
Job Inspector



V. Y. Bugale
Trainee Job Inspector



Kalpana Konda
CMM Operator

Interested in joining our committed team?

Write to us at careers@lhpmotor.com

Solapur



An ancient palace built in 18th century is an archeological heritage site in Solapur. Now, various offices of Solapur Municipal Corporation are located in this majestic building.

Commendable Performance



A m a a n Shamlik, son of our team member Mr. A n w a r S h a m l i k participated in a state level essay competition, organised by Liberty School Pvt. Ltd., Pune and was awarded a merit certificate for commendable performance. Amaan is studying in class IV in Indian Model School, Solapur.
 Congratulations! Keep it up! Amaan!



Birthday Wishes



Aaditya More
16 March



Ajinkya Ankush Jadhav
14 April



Akanksha Ankush Jadhav
22 Jan



Danish A. Razzak Damdoti
29 April



Kunal Vijaykumar Mokashi
18 April



Mallikarjun Sidharam Yamaji
19 April



Pawankumar Santosh Habib
3 April



Pranav Bhangde
12 Feb



Pratham Bhangde
3 March



Viraj Ravindra Mashal
30 April



Sujal Nandkumar Rathod
29 March



Puja Rajendra Bansode
9 April



Samarth Sidhappa Nande
27 Feb



Sneha Parmeshwar Baliphade
21 April



Sanskruti Nitin Pukate
9 Feb



Rohit Digambar Awatade
17 April

LHP family wishes you a happy and prosperous married life



LHP team member Ganesh weds Kavita

Laxmi Hydraulics Pvt. Ltd.

Corporate Office : B-11, MIDC, Chincholi, Solapur - 413 255 INDIA
 Tel. : +91 - 217 - 2357001 (5 Lines) Fax : +91 - 217 - 2357006
 E-mail : lhpindia@lhpmotor.com Website : www.lhp.co.in

